

Data Sheet

Electric expansion valves
Type **AKVA 10**, **AKVA 15** and **AKVA 20**

Designed for ammonia refrigerating plant

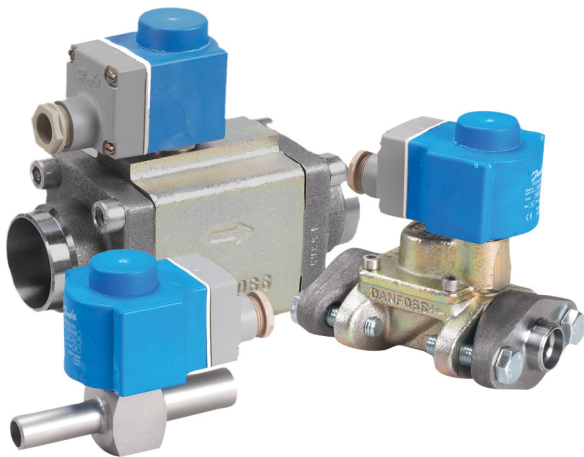

AKVA are electric expansion valves designed for ammonia refrigerating plant.

The AKVA valves are normally controlled by a controller from Danfoss' range of ADAP-KOOL® controllers.

The AKVA valves are supplied as a component programme, as follows:

- Separate valve
- Separate coil with terminal box or cable
- Spare parts in the form upper part, orifice and filter

The individual capacities are indicated with a number forming part of the type designation. The number represents the size of the orifice of the valve in question.

A valve with orifice 3 will for example be designated AKVA 10-3.

The orifice assembly is replaceable.

Features

- The valve requires no adjustment
- Wide regulation range
- Replaceable orifice assembly
- Wide range of coils for d.c. and a.c.
- Quick reaction in whole range of stated capacity.
- In some applications AKVA can be used both as expansion valve and solenoid valve.
- Classification: DNV, CRN, BV, EAC etc. To get an updated list of certification on the products please contact your local Danfoss Sales Company.

Functions

The valve capacity is regulated by means of pulse-width modulation. Within a period of six seconds a voltage signal from the controller will be transmitted to and removed from the valve coil. This makes the valve open and close for the flow of refrigerant.

Figure 1: Function

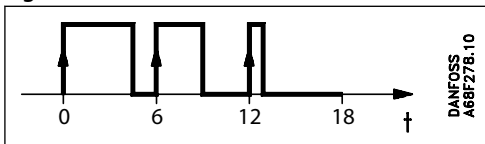

The relation between this opening and closing time indicates the actual capacity. If there is an intense need for refrigeration, the valve will remain open for almost all six seconds of the period. If the required amount of refrigeration is modest, the valve will only stay open during a fraction of the period. The amount of refrigeration needed is determined by the controller. When no refrigeration is required, the valve will remain closed. In some applications, AKVA can advantage-ously be used both as expansion valve and solenoid valve. See [Applications](#)

Applications

Recommendations

It is important to realize when AKVA is operating, that the valve always is fully open or fully closed. That means that this way of operation should always be considered during the refrigeration design. (Piping, liquid velocity, sub cooling etc.)

Danfoss have the following recommendations/guidelines to be taken into considerations:

- In 1:1 applications (1 evaporator, 1 condenser and 1 compressor) chillers with a small amount of refrigerant or installed in front of a Plate Heat Exchangers, it must be observed that every time the AKVA is fully open or closed it will have a significant impact on the whole system. (e.g. pressure variations on suction side).
Please observe that the performance of such a system is not only related to one component. (e.g. AKVA) Other factors which is very important to include in the overall refrigeration system design:
 - Liquid distribution at and design of evaporator
 - total evaporator coil is of adequate length thus superheat can be controlled within the entered period time (normal 6 sec. or 3 sec.)
 - mounting principle of temperature sensor, to ensure a steady and fast signal can be detected by the electronic system.
- If pressure dependent valves like, ICS with pilots like CVP e.t.c., is installed between evaporator and compressor, it can effect the lifetime of ICS, because the piston of the ICS will operate together with operation of AKVA. Type of refrigerant and evaporator has a big influence of the size of pulsations after the evaporator and in front of the ICS.
- AKVA is a direct pressure independent valve. That means that if non-Danfoss electronic controllers is used, intelligent and fast optimal control is needed, because the quick pressure changes only can be detected and compensated via the electronic control system.
- Liquid lines must be designed according to AKVA capacity and not evaporator capacity.
- To avoid flash-gas ensure sufficient sub-cooling or design liquid lines thus to big pressure drop is avoided, when AKVA is open. If not sufficient subcooling is not obtained (normally 4K) it will have an impact on the lifetime of the valve).
- Where the demand for safety level is extremely high, (e.g. Liquid Level Control in a pump separator) an extra valve can be installed in front of AKVA to avoid leakage. This valve must be Danfoss type EVRAT.
- Always install a 100 µm filter in front of AKVA 15 and AKVA 20 valves.
- If AKVA has to be used in chillers. Please contact Danfoss.

Media

Refrigerants

For R717 (Ammonia) and R744 (CO₂)

New refrigerants

Danfoss products are continually evaluated for use with new refrigerants depending on market requirements.

When a refrigerant is approved for use by Danfoss, it is added to the relevant portfolio, and the R number of the refrigerant (e.g. R513A) will be added to the technical data of the code number. Therefore, products for specific refrigerants are best checked at store.danfoss.com/en/, or by contacting your local Danfoss representative.

Product specification

Design

Figure 2: AKVA 10

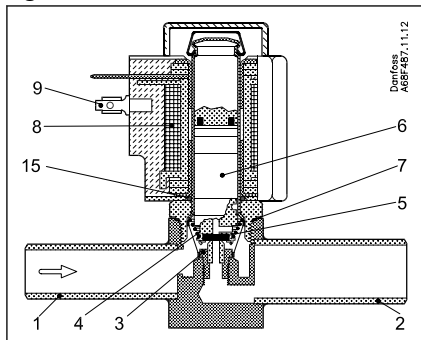

Figure 3: AKVA 15

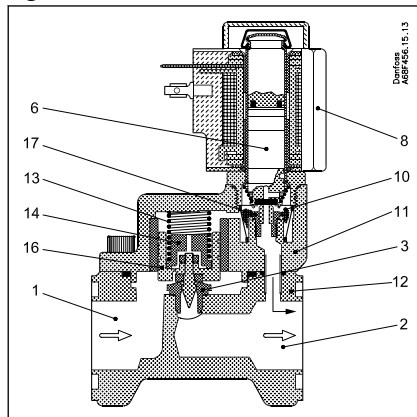
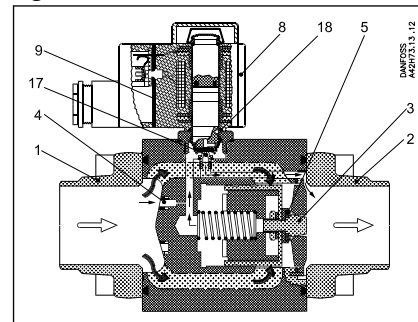

Figure 4: AKVA 20



1.	Inlet	7.	Aluminium gasket	13.	Spring
2.	Outlet	8.	Coil	14.	Orifice assembly
3.	Orifice	9.	DIN plug	15.	O-ring
4.	Filter	10.	Filter	16.	Piston assembly
5.	Valve seat	11.	Cover	17.	Pilot orifice
6.	Armature	12.	Valve body	18.	Pilot valve

The AKVA 10 valves covers a capacity range from 4 kW to 100 kW (R 717) and are divided into 8 capacity ranges. The AKVA 10 valve bodies are made in stainless steel and have weld connections..

The AKVA 15 valves covers a capacity range from 125 kW to 500 kW (R 717) and are divided into 4 capacity ranges. The AKVA 15 valves have flange connections.

The AKVA 20 valves cover a capacity range from 500 kW to 3150 kW (R 717) and are divided into 5 capacity ranges. The AKVA 20 valve has weld connections.

The AKVA valves can be used for:

- Flooded evaporation (high/low pressure)
- Pump separators
- Direct expansion. See [Applications](#).

If AKVA has to be used in chillers please contact Danfoss.

Table 1: Technical data

Valve type	AKVA 10	AKVA 15	AKVA 20
Tolerance of coil voltage	+10 / -15%	+10 / -15%	+10 / -15%
Enclosure to IEC 529	Max. IP 67	Max. IP 67	Max. IP 67
Working principle (Pulse-width modulation)	PWM	PWM	PWM
Recommend period of time	6 seconds	6 seconds	6 seconds
Capacity (R717)	4 to 100 kW	125 to 500 kW	500 to 3150 kW
Regulation range	10 - 100%	10 - 100%	10 - 100%
Connection	Weld	Weld	Weld
Media temperature	- 50 to 60 °C	- 40 to 60 °C	- 40 to 60 °C
Ambient temperature	- 50 to 50 °C	- 40 to 50 °C	- 40 to 50 °C
Leak of valve seat	< 0.02% of kv-value	< 0.02% of kv-value	< 0.02% of kv-value
MOPD	18 bar	22 bar	18 bar
Filter	Internal 100 µm replaceable	external 100 µm	external 100 µm
Max. working pressure	PS = 42 bar	PS = 42 bar	PS = 42 bar

Valve selection based on capacity calculation

As for extended capacity calculations and valve selection based on capacities and refrigerants, please refer to **Coolselector®2**. Rated and extended capacities are calculated with the Coolselector®2 calculation engine to ARI standards with the ASEREP equations based on laboratory measurements of selected valves. Download Coolselector®2 for free at coolselector.danfoss.com.

Dimensioning

To obtain an expansion valve that will function correctly under different load conditions it is necessary to consider the following points when the valve has to be dimensioned.

These points must be dealt with in the following sequence:

1. Evaporator capacity
2. Pressure drop across the valve
3. Subcooling
4. Evaporation saturated temperature
5. Correctly dimensioned liquid line

Points 1 to 4 are considered when using Coolselector to size the AKVA. Additionally a calculation can be made in Coolselector to size the liquid line according to the selected AKVA max capacity.

Example for a direct expansion system

Evaporator capacity

The evaporator capacity is found in the specifications from the evaporator supplier.

Pressure drop across the valve

The pressure drop across the valve directly determines the capacity and must therefore be considered. The pressure drop across the valve is normally calculated as the condensing pressure minus the evaporating pressure and other pressure drops in the liquid line, distributor, evaporator, etc. It is indicated in the following formula: $\Delta p_{\text{valve}} = p_c - (p_e + \Delta p_1 + \Delta p_3 + \Delta p_4)$

Figure 5: Example of a direct expansion system

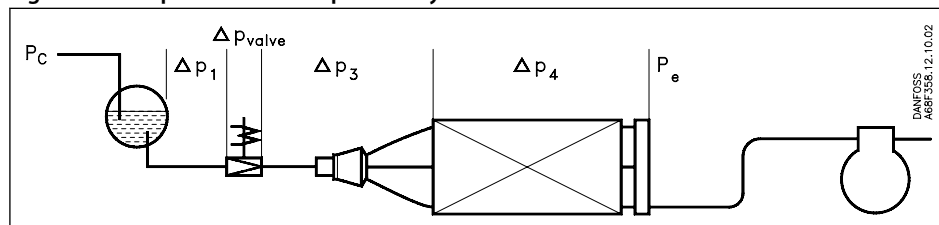

Δp_{valve}	pressure drop across the valve	Δp_1	pressure drop across the liquid line
p_c	condensing pressure	Δp_3	pressure drop across the distributor system
p_e	evaporating pressure	Δp_4	pressure drop across the evaporator

NOTE:

The pressure drop across the liquid line and the distributor system must be calculated on the basis of the valve's max. capacity, as the valve operates with pulse-width modulation.

Correctly dimensioned liquid line

To obtain a correct supply of liquid to the AKVA valve, the liquid line to the individual AKVA valve must be correctly dimensioned. The liquid flow rate must not exceed 1 m/sec at a fully open valve.

This must be observed on account of the pressure drop in the liquid line (lack of subcooling) and pulsations in the liquid line.

Dimension and weight

Figure 6: Dimension

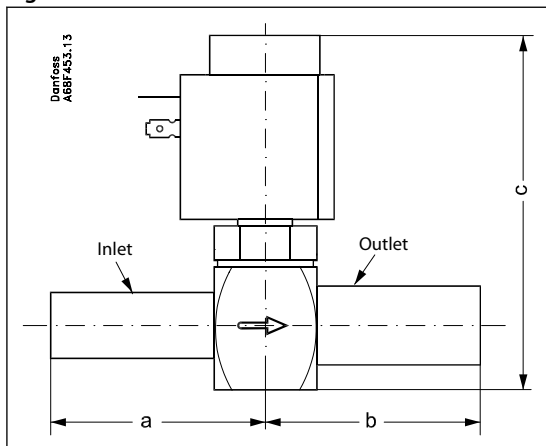

Table 2: AKVA 10

Valve type		A	B	C	Connection		Weight without coil
					Inlet	Outlet	
		mm	mm	mm	in.	in.	kg
AKVA 10	1 – 6	60	60	113	3/8	1/2	0.35
AKVA 10	7 – 8	60	60	113	1/2	3/4	0.35

Table 3: Dimensions

AKVA 15	AKVA 20
<p>Technical drawing of AKVA 15 valve. Dimensions shown: 121 (total height), 26 (coil height), 78 (inlet length), 96 (outlet length), and L (total length).</p>	<p>Technical drawing of AKVA 20 valve. Dimensions shown: 115 (total height), 48 (coil height), 47 (inlet length), 80 (outlet length), 83 (inlet length), and 175 (total length).</p>
<p>L = 148 mm Weight without coil = 2.0 kg</p>	<p>Weight without coil = 4.1 kg</p>

Ordering

Rated capacity and ordering

Figure 7: Ordering

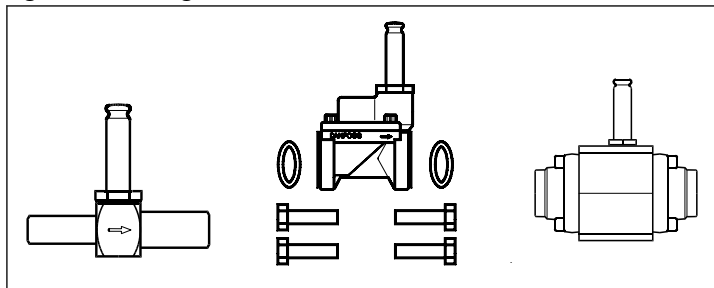

Table 4: Rated capacity

Valve type	Rated capacity ⁽¹⁾		kv-value	Connections Inlet x outlet	Code no.	Connections Inlet x outlet	Code no.
	kW	tons	m ³ /h	in.		in.	
AKVA 10-1	4	1.1	0.01	3/8 x 1/2	068F3261	1/2 x 3/4	068F3281
AKVA 10-2	6.3	1.8	0.015	3/8 x 1/2	068F3262	1/2 x 3/4	068F3282
AKVA 10-3	10	2.8	0.022	3/8 x 1/2	068F3263	1/2 x 3/4	068F3283
AKVA 10-4	16	4.5	0.038	3/8 x 1/2	068F3264	1/2 x 3/4	068F3284
AKVA 10-5	25	7.1	0.055	3/8 x 1/2	068F3265	1/2 x 3/4	068F3285
AKVA 10-6	40	11.4	0.103	3/8 x 1/2	068F3266	1/2 x 3/4	068F3286
AKVA 10-7	63	17.9	0.162			1/2 x 3/4	068F3267
AKVA 10-8	100	28.4	0.251			1/2 x 3/4	068F3268
AKVA 15-1	125	35	0.25	Flange	068F5020 ⁽²⁾		
AKVA 15-2	200	60	0.4	Flange	068F5023 ⁽²⁾		
AKVA 15-3	300	90	0.63	Flange	068F5026 ⁽²⁾		
AKVA 15-4	500	140	1	Flange	068F5029 ⁽²⁾		
AKVA 20-1	500	140	1	1 1/4 x 1 1/4	042H2101		
AKVA 20-2	800	240	1.6	1 1/4 x 1 1/4	042H2102		
AKVA 20-3	1250	350	2.5	1 1/4 x 1 1/4	042H2103		
AKVA 20-4	2000	600	4	1 1/2 x 1 1/2	042H2104		
AKVA 20-5	3150	900	6.3	2 x 2	042H2105		

⁽¹⁾ Rated capacities are based on
 Condensing temperature $t_c = 32\text{ °C}$
 Liquid temperature $t_l = 28\text{ °C}$
 Evaporating temperature $t_e = 5\text{ °C}$

⁽²⁾ Incl. bolts and gaskets but without flanges

Figure 8: Flange

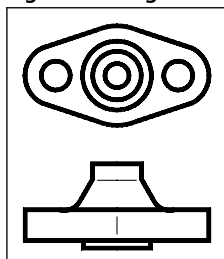

Table 5: Flange set for AKVA 15

Valve type	Connection (in.)	Code no.
AKVA 15-1 to 4	3/4	027N1220
	1	027N1225

Accessories

Strainer

On plants with ammonia and similar industrial plant a strainer must be mounted in front of AKVA 15 and AKVA 20. AKVA 10 has built-in strainer and external strainer is not necessary.

Figure 9: Strainer

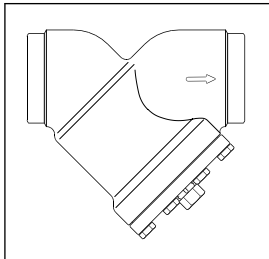
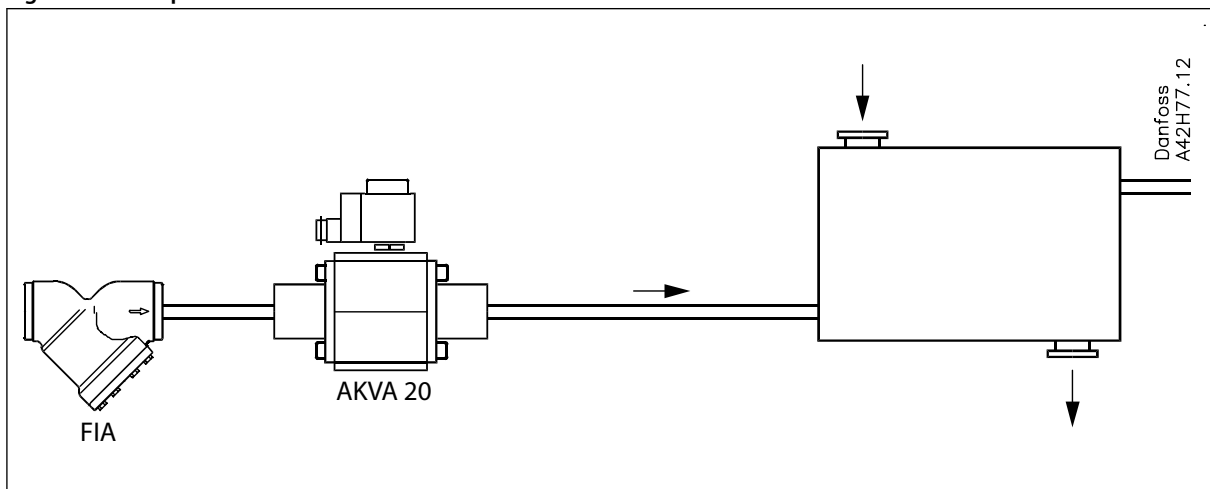

Table 6: Recommended strainer for AKVA 15 / 20

Strainer type	Code no.	
	House	Strainer insert 100 mm
FIA 20 D STR	148B5343	148H3122
FIA 25 D STR	148B5443	148H3123
FIA 32 D STR	148B5544	
FIA 40 D STR	148B5625	148H3157
FIA 50 D STR	148B5713	

For further information: see Danfoss catalogue AI222586432958

Figure 10: Example of combinations



Spare parts

AKVA 10

Figure 11: Orifice

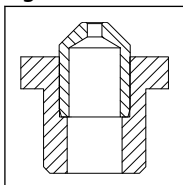

Table 7: Orifice

Type	Code no.	Contents
AKVA 10-1	068F0526	1 pcs. orifice 1 pcs. Al. gasket 1 pcs. cap for coil
AKVA 10-2	068F0527	
AKVA 10-3	068F0528	
AKVA 10-4	068F0529	
AKVA 10-5	068F0530	
AKVA 10-6	068F0531	
AKVA 10-7	068F0532	
AKVA 10-8	068F0533	

Figure 12: Filter

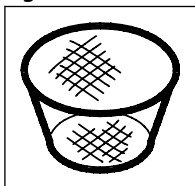

Table 8: Filter

Code no.	Contents
068F0540	10 pcs. filters 10 pcs. Al. gaskets

Figure 13: Upper part

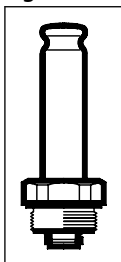

Table 9: Upper part

Code no.	Contents
068F5045	1 pcs. armature 1 pcs. armature tube 1 pcs. Al. gasket

AKVA 15

Figure 14: Piston

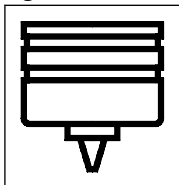

Table 10: Piston

Type	Code no.	Contents
AKVA 15-1	068F5265	1 pcs. piston assembly 1 pcs. gasket 1 pcs. O-ring 2 pcs. labels
AKVA 15-2	068F5266	
AKVA 15-3	068F5267	
AKVA 15-4	068F5268	

Table 11: Piston

Type	Code no.	Contents
Gasket set	068F5264	Complete gasket set

Figure 15: Orifice set

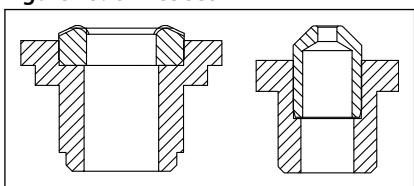

Table 12: Orifice set

Code no.	Contents
068F5261	Main orifice Pilot orifice Al gaskets O-rings Gasket

Figure 16: Upper part

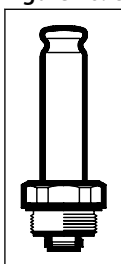

Table 13: Upper part

Code no.	Contents
068F5045	1 pcs. armature 1 pcs. armature tube 1 pcs. Al. gasket

Figure 17: Filter

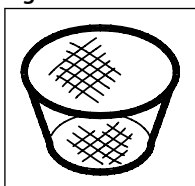

Table 14: Filter

Code no.	Contents
068F0540	10 pcs. filters 10 pcs. Al. gaskets

AKVA 20

Figure 18: Piston

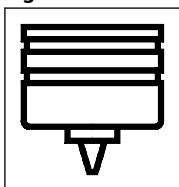

Table 15: Piston

Type	Code no.	Contents
AKVA 20-0.6	042H2039	1 pcs. piston assembly 3 pcs. O-rings
AKVA 20-1	042H2040	
AKVA 20-2	042H2041	
AKVA 20-3	042H2042	
AKVA 20-4	042H2043	
AKVA 20-5	042H2044	

Figure 19: Orifice set

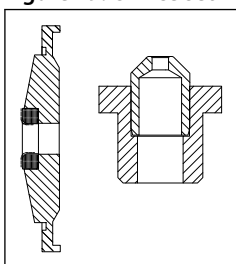

Table 16: Orifice set

Type	Code no.	Contents
AKVA 20-0.6	068F5270	Main orifice, dia. 8 mm Pilot orifice, dia. 1.8 mm 2 pcs. Al. gaskets O-ring
AKVA 20-1	068F5270	
AKVA 20-2	068F5270	
AKVA 20-3	068F5270	
AKVA 20-4	068F5271	
AKVA 20-5	068F5271	Main orifice, dia. 14 mm Pilot orifice, dia. 2.4 mm 2 pcs. Al. gaskets O-ring

Table 17: Gasket set

Type	Code no.	Contents
Gasket set	042H0160	Complete gasket set for new and old valves

Figure 20: Upper part

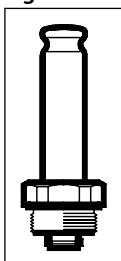

Table 18: Upper part

Code no.	Contents
068F5045	1 pcs. armature 1 pcs. armature tube 1 pcs. Al. gasket

Coils for AKVA valves

Table 19: Coils for AKVA valves

D.C. coils	Code no.	AKVA	AKVA	AKVA	AKVA	AKVA	AKVA
		10-1	10-6	10-7	15-1	20-1	20-4
				10-8	15-2	20-2	20-5
					15-3	20-3	
					15-4		
220 V DC 20 W, standard with terminal box	018F6851	+	+	+	+	+	+
100 V DC 18 W, special with terminal box with DIN plugs	018F6780	+	+	+	+	+	+
230 V DC 18 W, special with terminal box with DIN plugs	018F6781 ⁽¹⁾	+	+	+	+	+	+
	018F6991 ⁽¹⁾						
230 V DC 18 W, special with 2.5 m cable with 4.0 m cable with 8.0 m cable	018F6288 ⁽¹⁾						
	018F6278 ⁽¹⁾	+	+	+	+	+	+
	018F6279 ⁽¹⁾						

Electric expansion valves, Type AKVA 10, AKVA 15 & AKVA 20

⁽¹⁾ Recommended for commercial refrigeration plant

Table 20: Coils for AKVA valves

A.C. coils	Code no.	AKVA	AKVA	AKVA	AKVA	AKVA	AKVA
		10-1	10-6	10-7	15-1	20-1	20-4
		10-2		10-8	15-2	20-2	20-5
		10-3			15-3	20-3	
		10-4			15-4		
		10-5					
240 V AC 10 W, 50 Hz with terminal box with DIN plugs	018F6702						
	018F6177	+	+	-	+	-	-
240 V AC 10 W, 60 Hz with terminal box with DIN plugs	018F6713	+	+	-	+	-	-
240 V a.c. 12 W, 50 Hz with terminal box	018F6802	+	+	+	+	+	-
220 V AC 10 W, 50 Hz with terminal box with DIN plugs	018F6701						
	018F6176	+	+	-	+	-	-
220 V a.c. 10 W, 60 Hz with terminal box with DIN plugs	018F6714						
	018F6189	+	+	-	+	-	-
220 V AC 12 W, 50 Hz with terminal box	018F6801	+	+	-	+	+	-
220 V a.c. 12 W, 60 Hz with terminal box	018F6814	+	+	-	+	+	-
115 V AC 10 W, 50 Hz with terminal box with DIN plugs	018F6711						
	018F6186	+	+	-	+	-	-
115 V AC 10 W, 60 Hz with terminal box with DIN plugs	018F6710						
	018F6185	+	+	-	+	-	-
110 V a.c. 12 W, 50 Hz with terminal box	018F6811	+	+	-	+	+	-
110 V a.c. 12 W, 60 Hz with terminal box	018F6813	+	+	-	+	+	-
24 V AC 10 W, 50 Hz with terminal box with DIN plugs	018F6707						
	018F6182	+	-	-	+	-	-
24 V AC 10 W, 60 Hz with terminal box with DIN plugs	018F6715	+	-	-	+	-	-
24 V AC 12 W, 50 Hz with terminal box	018F6807	+	-	-	+	+	+
24 V AC 12 W, 60 Hz with terminal box	018F6815	+	-	-	+	+	+
24 V AC 20 W, 50 Hz with terminal box	018F6901	+	+	+	+	+	+
24 V AC 20 W, 60 Hz with terminal box	018F6902	+	+	+	+	+	+

Certificates, declarations, and approvals

The list contains all certificates, declarations, and approvals for this product type. Individual code number may have some or all of these approvals, and certain local approvals may not appear on the list.

Some approvals may change over time. You can check the most current status at danfoss.com or contact your local Danfoss representative if you have any questions.

Table 21: Valid approvals

Type	File name	Document type	Document topic	Approval authority
AKVA	MH7648	Electrical - Safety Certificate	UL	
	MD 033F0686.AH	Manufacturers Declaration	PED	Kolding - Denmark
	MD 033F0691.AE	Manufacturers Declaration	RoHS	Kolding - Denmark
	RU Д-ДК.БЛ08.В.00189_18	EAC Declaration	EMC	Kolding - Denmark
	RU Д-ДК.БЛ08.В.00191_18	EAC Declaration	Machinery & Equipment	Kolding - Denmark
	RU Д-ДК.РА01.В.72054_20	EAC Declaration	PED	Kolding - Denmark
	033F0474.AC	Manufacturers Declaration	ATEX	Kolding - Denmark
	RMRS 19.10034.262	Marine - Safety Certificate		Kolding - Denmark
	TSSA CRN 0C22766.5267890YTN	Pressure - Safety Certificate	CRN	Kolding - Denmark
	TUV 0045 202 1204 Z 00354 19 D 001(00)	Pressure - Safety Certificate		Kolding - Denmark
	UL MH7648	Electrical - Safety Certificate		Kolding - Denmark

Approvals

- DEMKO, Denmark SETI, Finland SEV, Switzerland
- AKVA 20 are CE marked according to pressure Equipment Directive 97/23
-  UL listed to U.S. and Canadian standards (separate code nos.)

Online support

Danfoss offers a wide range of support along with our products, including digital product information, software, mobile apps, and expert guidance. See the possibilities below.

The Danfoss Product Store



The Danfoss Product Store is your one-stop shop for everything product related—no matter where you are in the world or what area of the cooling industry you work in. Get quick access to essential information like product specs, code numbers, technical documentation, certifications, accessories, and more.

Start browsing at store.danfoss.com.

Find technical documentation



Find the technical documentation you need to get your project up and running. Get direct access to our official collection of data sheets, certificates and declarations, manuals and guides, 3D models and drawings, case stories, brochures, and much more.

Start searching now at www.danfoss.com/en/service-and-support/documentation.

Danfoss Learning



Danfoss Learning is a free online learning platform. It features courses and materials specifically designed to help engineers, installers, service technicians, and wholesalers better understand the products, applications, industry topics, and trends that will help you do your job better.

Create your Danfoss Learning account for free at www.danfoss.com/en/service-and-support/learning.

Get local information and support



Local Danfoss websites are the main sources for help and information about our company and products. Find product availability, get the latest regional news, or connect with a nearby expert—all in your own language.

Find your local Danfoss website here: www.danfoss.com/en/choose-region.

Spare Parts



Get access to the Danfoss spare parts and service kit catalog right from your smartphone. The app contains a wide range of components for air conditioning and refrigeration applications, such as valves, strainers, pressure switches, and sensors.

Download the Spare Parts app for free at www.danfoss.com/en/service-and-support/downloads.

Coolselector®2 - find the best components for you HVAC/R system



Coolselector®2 makes it easy for engineers, consultants, and designers to find and order the best components for refrigeration and air conditioning systems. Run calculations based on your operating conditions and then choose the best setup for your system design.

Download Coolselector®2 for free at coolselector.danfoss.com.

Danfoss A/S

Climate Solutions • danfoss.com • +45 7488 2222

Any information, including, but not limited to information on selection of product, its application or use, product design, weight, dimensions, capacity or any other technical data in product manuals, catalogues descriptions, advertisements, etc. and whether made available in writing, orally, electronically, online or via download, shall be considered informative, and is only binding if and to the extent, explicit reference is made in a quotation or order confirmation. Danfoss cannot accept any responsibility for possible errors in catalogues, brochures, videos and other material. Danfoss reserves the right to alter its products without notice. This also applies to products ordered but not delivered provided that such alterations can be made without changes to form, fit or function of the product.

All trademarks in this material are property of Danfoss A/S or Danfoss group companies. Danfoss and the Danfoss logo are trademarks of Danfoss A/S. All rights reserved.